

## Data sheet | Item number: 221-2411 **NEW**

Inline splicing connector with lever; for all conductor types; max. 4 mm<sup>2</sup>; 2-conductor; transparent housing; Transparent cover; Surrounding air temperature: max 85°C (T85); 4,00 mm<sup>2</sup>; transparent

[www.wago.com/221-2411](http://www.wago.com/221-2411)

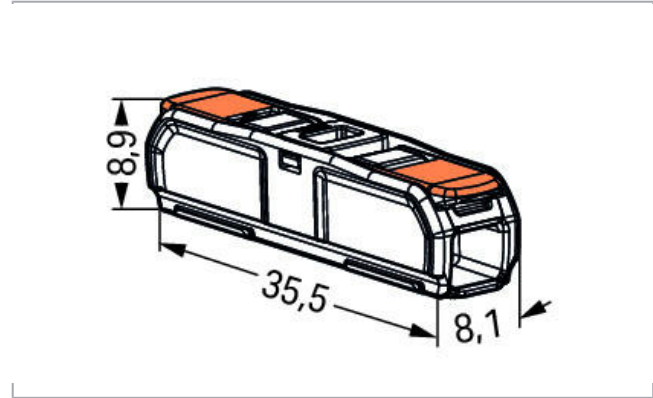
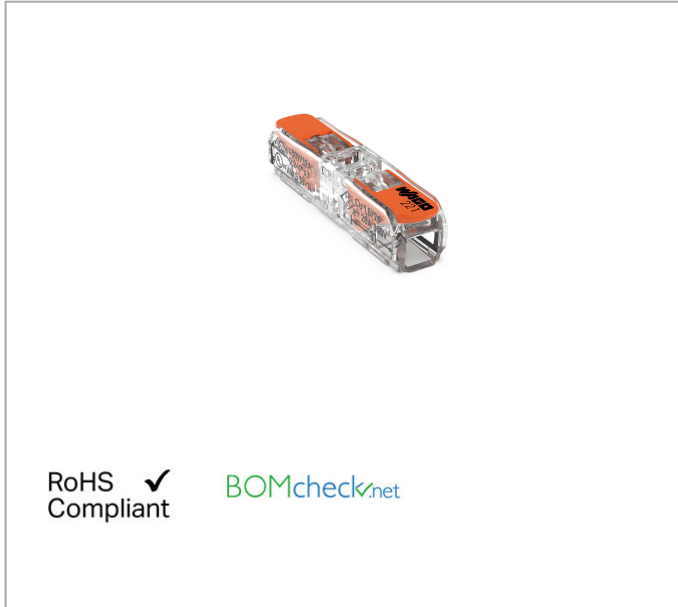

### Data

#### Electrical data

#### Ratings per IEC/EN 60664-1

Ratings per	EN 60664
Nominal voltage (II/2)	450 V
Rated surge voltage (II/2)	4 kV
Rated current	32 A
Legend (ratings)	(II / 2) ≙ Overvoltage category II / Pollution degree 2

#### Ratings per UL 1059

Rated voltage UL (Use Group C)	600 V
Rated current UL (Use Group C)	20 A

#### Connection data

Connection technology	CAGE CLAMP®
Actuation type	Lever

Subject to changes. Please also observe the further product documentation!

WAGO Corporation  
Germantown, WI 53022  
Phone: 1-800-DIN-RAIL (346-7245) | Fax: (262) 255-6222  
Email: [info.us@wago.com](mailto:info.us@wago.com) | Web: [www.wago.us](http://www.wago.us)

Do you have any questions about our products?  
We are always happy to take your call at {0}.

Connectable conductor materials	Copper
Solid conductor	0.2 ... 4 mm <sup>2</sup> / 20 ... 14 AWG
Stranded conductor	0.2 ... 2.5 mm <sup>2</sup> / 18 ... 14 AWG
Fine-stranded conductor	0.2 ... 4 mm <sup>2</sup> / 18 ... 14 AWG
Strip length	11 mm / 0.43 inch
Total number of connection points	2

### Physical data

Width	8.1 mm / 0.319 inch
Height	8.9 mm / 0.35 inch
Depth	35.5 mm / 1.398 inch

### Material data





Color	transparent
Flammability class per UL94	V2
Color of actuator	orange
Weight	3.6 g

### Commercial data

Packaging type	BOX
Country of origin	DE
GTIN	4055144049404
Customs tariff number	85369010000

















### Compatible products

#### assembling

	<b>Item no.: 221-2501</b> Mounting carrier with strain relief; 1-way; for inline splicing connector with lever; for screw mounting; gray	<a href="http://www.wago.com/221-2501">www.wago.com/221-2501</a>
	<b>Item no.: 221-2502</b> Mounting carrier with strain relief; 2-way; for inline splicing connector with lever; for screw mounting; gray	<a href="http://www.wago.com/221-2502">www.wago.com/221-2502</a>
	<b>Item no.: 221-2503</b> Mounting carrier with strain relief; 3-way; for inline splicing connector with lever; for screw mounting; gray	<a href="http://www.wago.com/221-2503">www.wago.com/221-2503</a>
	<b>Item no.: 221-2504</b> Mounting carrier with strain relief; 4-way; for inline splicing connector with lever; for screw mounting; gray	<a href="http://www.wago.com/221-2504">www.wago.com/221-2504</a>
	<b>Item no.: 221-2505</b>	

Subject to changes. Please also observe the further product documentation!



	Mounting carrier with strain relief; 5-way; for inline splicing connector with lever; for screw mounting; gray	<a href="http://www.wago.com/221-2505">www.wago.com/221-2505</a>
<hr/>		
	<b>Item no.: 221-2511</b>	
	Mounting carrier with strain relief; 1-way; for inline splicing connector with lever; with snap-in mounting foot; gray	<a href="http://www.wago.com/221-2511">www.wago.com/221-2511</a>
<hr/>		
	<b>Item no.: 221-2512</b>	
	Mounting carrier with strain relief; 2-way; for inline splicing connector with lever; with snap-in mounting foot; gray	<a href="http://www.wago.com/221-2512">www.wago.com/221-2512</a>
<hr/>		
	<b>Item no.: 221-2513</b>	
	Mounting carrier with strain relief; 3-way; for inline splicing connector with lever; with snap-in mounting foot; gray	<a href="http://www.wago.com/221-2513">www.wago.com/221-2513</a>
<hr/>		
	<b>Item no.: 221-2514</b>	
	Mounting carrier with strain relief; 4-way; for inline splicing connector with lever; with snap-in mounting foot; gray	<a href="http://www.wago.com/221-2514">www.wago.com/221-2514</a>
<hr/>		
	<b>Item no.: 221-2515</b>	
	Mounting carrier with strain relief; 5-way; for inline splicing connector with lever; with snap-in mounting foot; gray	<a href="http://www.wago.com/221-2515">www.wago.com/221-2515</a>
<hr/>		
	<b>Item no.: 221-2521</b>	
	Mounting carrier; 1-way; for inline splicing connector with lever; for screw mounting; gray	<a href="http://www.wago.com/221-2521">www.wago.com/221-2521</a>
<hr/>		
	<b>Item no.: 221-2522</b>	
	Mounting carrier; 2-way; for inline splicing connector with lever; for screw mounting; gray	<a href="http://www.wago.com/221-2522">www.wago.com/221-2522</a>
<hr/>		
	<b>Item no.: 221-2523</b>	
	Mounting carrier; 3-way; for inline splicing connector with lever; for screw mounting; gray	<a href="http://www.wago.com/221-2523">www.wago.com/221-2523</a>
<hr/>		
	<b>Item no.: 221-2524</b>	
	Mounting carrier; 4-way; for inline splicing connector with lever; for screw mounting; gray	<a href="http://www.wago.com/221-2524">www.wago.com/221-2524</a>
<hr/>		
	<b>Item no.: 221-2525</b>	
	Mounting carrier; 5-way; for inline splicing connector with lever; for screw mounting; gray	<a href="http://www.wago.com/221-2525">www.wago.com/221-2525</a>
<hr/>		
	<b>Item no.: 221-2531</b>	
	Mounting carrier; 1-way; for inline splicing connector with lever; with snap-in mounting foot; gray	<a href="http://www.wago.com/221-2531">www.wago.com/221-2531</a>
<hr/>		
	<b>Item no.: 221-2532</b>	
	Mounting carrier; 2-way; for inline splicing connector with lever; with snap-in mounting foot; gray	<a href="http://www.wago.com/221-2532">www.wago.com/221-2532</a>
<hr/>		
	<b>Item no.: 221-2533</b>	
	Mounting carrier; 3-way; for inline splicing connector with lever; with snap-in mounting foot; gray	<a href="http://www.wago.com/221-2533">www.wago.com/221-2533</a>
<hr/>		
	<b>Item no.: 221-2534</b>	
	Mounting carrier; 4-way; for inline splicing connector with lever; with snap-in mounting foot; gray	<a href="http://www.wago.com/221-2534">www.wago.com/221-2534</a>
<hr/>		
	<b>Item no.: 221-2535</b>	
	Mounting carrier; 5-way; for inline splicing connector with lever; with snap-in mounting foot; gray	<a href="http://www.wago.com/221-2535">www.wago.com/221-2535</a>

## Downloads Documentation

Subject to changes. Please also observe the further product documentation!

WAGO Corporation  
 Germantown, WI 53022  
 Phone: 1-800-DIN-RAIL (346-7245) | Fax: (262) 255-6222  
 Email: [info.us@wago.com](mailto:info.us@wago.com) | Web: [www.wago.us](http://www.wago.us)

Do you have any questions about our products?  
 We are always happy to take your call at {0}.

Data sheet | Item number: 221-2411 **NEW**

[www.wago.com/221-2411](http://www.wago.com/221-2411)



#### Additional Information

Technical explanations

2019-4-3

pdf  
2.2 MB

Download

---

#### Installation Notes

Subject to changes. Please also observe the further product documentation!

---

WAGO Corporation  
Germantown, WI 53022  
Phone: 1-800-DIN-RAIL (346-7245) | Fax: (262) 255-6222  
Email: [info.us@wago.com](mailto:info.us@wago.com) | Web: [www.wago.us](http://www.wago.us)

Do you have any questions about our products?  
We are always happy to take your call at {0}.